

Valve – Supply and exhaust air

AIRY



Description

The valve is designed for installation at a wall or in a ceiling. It can be used for new-build and for replacement. Its smart grip function ensures an easy installation. Its unique sound data ensure an optimum sound level.

The valve consists of two parts; the valve body (AIRYB) and the flat front plate (AIRYFP). The valve body is fixed to the duct system or a valve socket via flexible spring wings. The front plate is attached to the valve body via springs.

There are 5 standard front plate shapes:

- ROUN – a circle,
 - BOW – a square with slightly bulged edges,
 - SQUA – a square,
 - ELLI – an super ellipse.
 - RECT – a rectangle,
- Special shapes are possible on request.

It is recommended that the valve is mounted in the frame ILVRU. The product will also fit in the valve frames VRGU, VRGM, VRFU, VRFM and the products BU GJUT, and TCPU GJUT. The valve body has to cover the brim of the product it is fitted into. Therefore the maximum diameter of the brim for Ø100 is 133,5 mm, for Ø125 is 152,5 mm and for Ø160 is 187,5 mm.

Can be equipped with a blanking – off sector plate for 2 or 3 way air flow.

Maintenance

The visible parts can be wiped off with a damp cloth.

Order code

| | | | |
|---------------------------|---------------------------|------------|------------|
| Product | AIRYB | aaa | bbb |
| AIRYB | | | |
| Connection dim. Ød | Ød nom = 100, 125, 160 mm | | |
| Colour | RAL 9003, RAL 9010 | | |

Example: AIRYB - 125 - 9003

| | | | | |
|---------------------------|-----------------------------|------------|------------|------------|
| Product | 100 | aaa | bbb | ccc |
| 100 | | | | |
| Connection dim. Ød | Ød nom = 100, 125, 160 mm | | | |
| Type | BOW, ELLI, RECT, ROUN, SQUA | | | |
| Colour | RAL 9003, RAL 9010 | | | |

Example: AIRYFP - 125 - ELLI - 9003

Dimensions

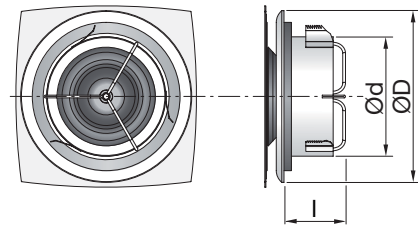

| Ød nom | Ød mm | ØD mm | l mm | m kg |
|--------|-------|-------|------|------|
| 100 | 90 | 137,5 | 54 | 0,13 |
| 125 | 114 | 156 | 57 | 0,18 |
| 160 | 149 | 191 | 57 | 0,28 |

AIRYFP BOW

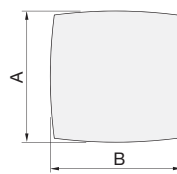

AIRYFP SQUA

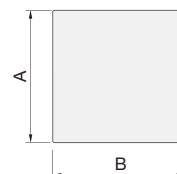

AIRYFP ROUN

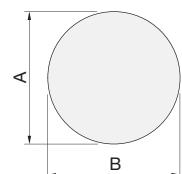

AIRYFP ELLI

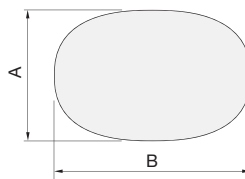

AIRYFP RECT

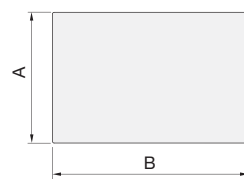

| Ød nom | A mm | B mm | Type | m kg |
|--------|------|------|------|------|
| 100 | 140 | 140 | BOW | 0,17 |
| 100 | 140 | 210 | ELLI | 0,21 |
| 100 | 140 | 140 | ROUN | 0,13 |
| 100 | 140 | 210 | RECT | 0,24 |
| 100 | 140 | 140 | SQUA | 0,17 |
| 125 | 165 | 165 | BOW | 0,22 |
| 125 | 165 | 248 | ELLI | 0,29 |
| 125 | 165 | 165 | ROUN | 0,18 |
| 125 | 165 | 248 | RECT | 0,33 |
| 125 | 165 | 165 | SQUA | 0,23 |
| 160 | 210 | 210 | BOW | 0,34 |
| 160 | 210 | 315 | ELLI | 0,44 |
| 160 | 210 | 210 | ROUN | 0,28 |
| 160 | 210 | 315 | RECT | 0,53 |
| 160 | 210 | 210 | SQUA | 0,35 |

Materials and finish

Material: Galvanized sheet metal.
 Colour: White RAL 9003, gloss 30 or white RAL 9010, gloss 30.

Special colours are available on request. The front plate can be ordered in stainless steel. It is also possible to paint the front plate with standard wall paint or to cover it with wallpaper.

Valve – Supply and exhaust air

AIRY

Technical data

Capacity

Air flow q_v [l/s] and [m³/h], total pressure Δp_t [Pa], throw $l_{0,2}$ [m] and sound power level L_{WA} [dB(A)] can be seen in the graphs.

Frequency-related sound power level

The sound power level in the frequency band is defined as $L_{WA} + K_{ok}$. K_{ok} values are specified in charts beneath the graphs on the following pages.

Sound attenuation

Sound attenuation of the diffusers ΔL from duct to room, including end reflection, see table below.

| Ød nom | Centre frequency [Hz] | | | | | | | |
|--------|-----------------------|-----|-----|-----|----|----|----|----|
| | 63 | 125 | 250 | 500 | 1K | 2K | 4K | 8K |
| 100 | 22 | 18 | 13 | 11 | 9 | 8 | 7 | 8 |
| 125 | 20 | 16 | 11 | 9 | 9 | 7 | 6 | 5 |
| 160 | 18 | 14 | 10 | 9 | 9 | 7 | 6 | 6 |

Balancing

Balancing data is contained in a separate brochure.

Blanking off sector plate

Correction for sound and throw

When using blanking off sector in Airy calculate correction factor C and use this factor to read corrected sound- and throw data:

$$C = ((\alpha / 360) + 1)$$

Corrected flow to use for reading data in diagrams = $C \times q_v$

Example

AIRY-125

Sector plate α : 120°

Airflow q_v : 20 l/s

Required pressure drop Δp_t : 50 pa

$$C = ((120 / 360) + 1) = 1,33$$

Corrected flow to use for reading data in diagrams = $1,33 \times 20 \text{ l/s} = 27 \text{ l/s}$

Corrected data:

Sound power level L_{wa} : 30 dB(A)

Slot setting for 50 pa : 12 mm

Throw l_{02} (12 mm. slot): 2,6 m

Accessories

Blanking – of sector plate

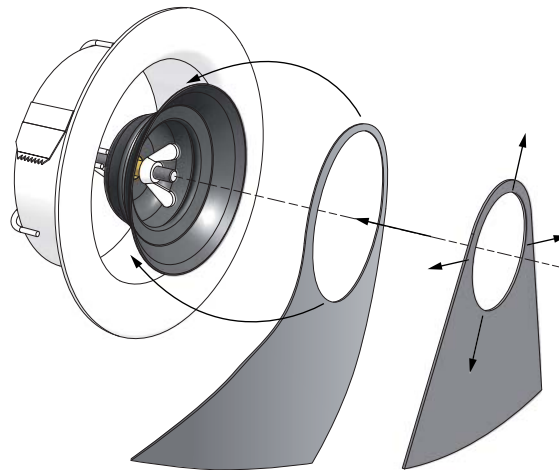

Order code

Product AIRYBP aaa
 AIRYB
Connection dim. Ød
 Ød nom = 100, 125, 160 mm

Example: AIRYBP - 125

Valve – Supply and exhaust air

AIRY

Technical data

Throw $l_{0,2}$

Throw $l_{0,2}$ [m] can be seen in the graphs for isothermal air, at a terminal velocity of 0,2 m/s.

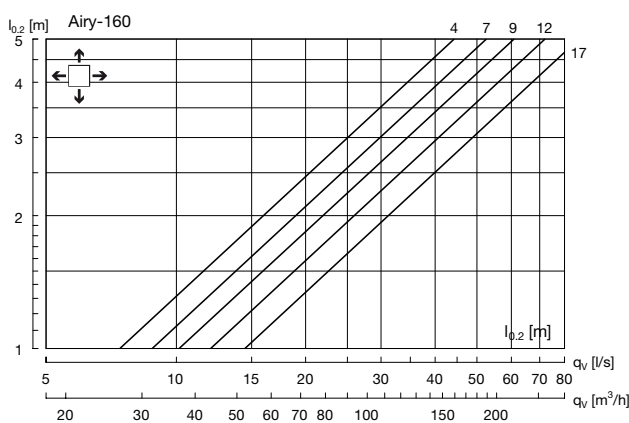
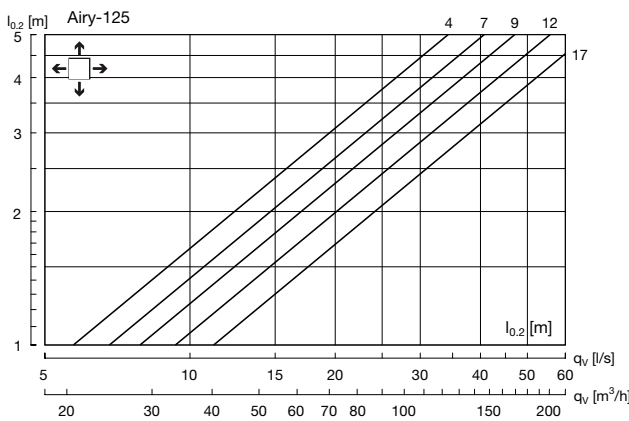
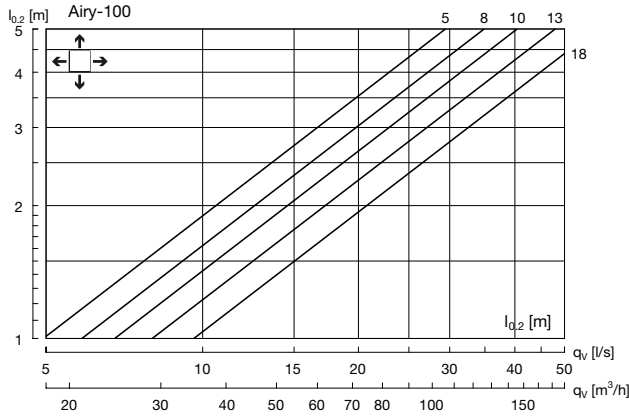

- 1
- 2
- 3
- 4
- 5
- 6
- 7
- 8
- 9
- 10
- 11
- 12
- 13
- 14
- 15
- 16
- 17
- 18

Valve – Supply and exhaust air

AIRY

Technical data

Supply air

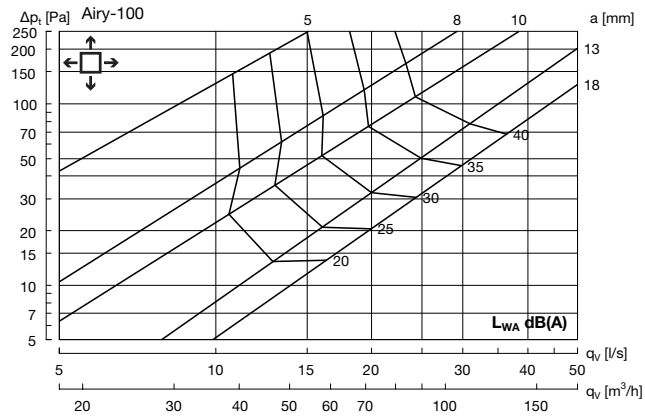

| Hz | 63 | 125 | 250 | 500 | 1K | 2K | 4K | 8K |
|----------|----|-----|-----|-----|----|-----|-----|-----|
| K_{sk} | 0 | -6 | 0 | 1 | -7 | -13 | -17 | -21 |

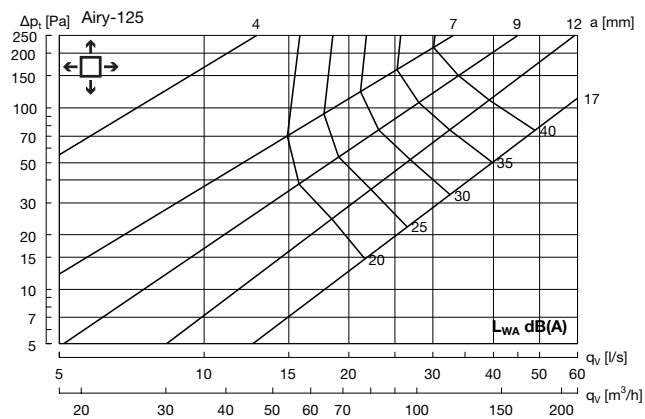

| Hz | 63 | 125 | 250 | 500 | 1K | 2K | 4K | 8K |
|----------|----|-----|-----|-----|----|-----|-----|-----|
| K_{sk} | 4 | -6 | -1 | 0 | -6 | -11 | -15 | -15 |

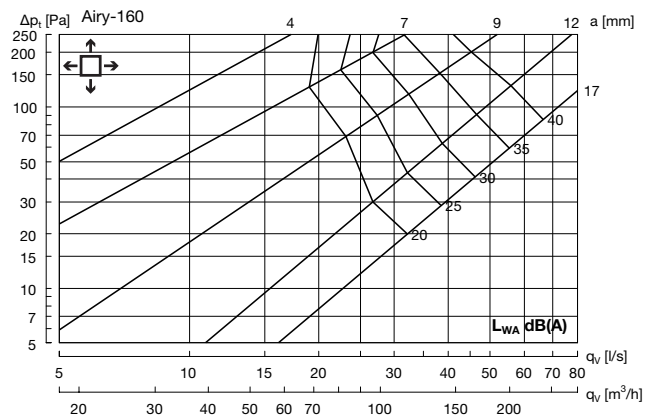

| Hz | 63 | 125 | 250 | 500 | 1K | 2K | 4K | 8K |
|----------|----|-----|-----|-----|----|-----|-----|-----|
| K_{sk} | 4 | -4 | -1 | -1 | -6 | -10 | -13 | -13 |

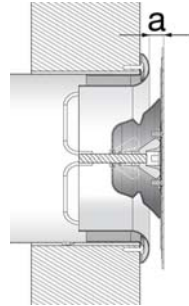

Valve – Supply and exhaust air

AIRY

Technical data

Exhaust air

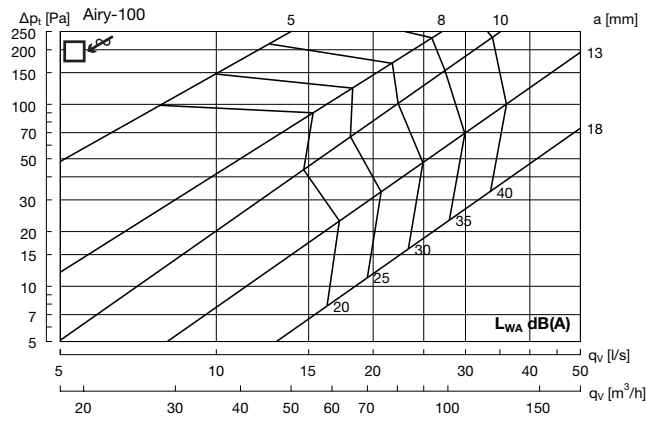

| Hz | 63 | 125 | 250 | 500 | 1K | 2K | 4K | 8K |
|----------|----|-----|-----|-----|----|----|-----|-----|
| K_{sk} | 8 | -11 | -3 | 0 | -7 | -9 | -15 | -15 |

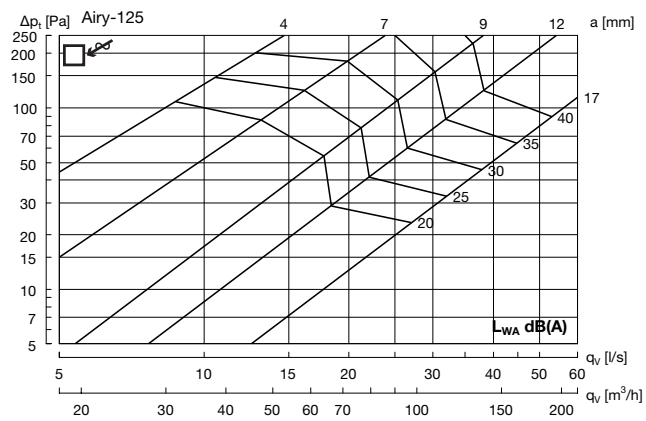

| Hz | 63 | 125 | 250 | 500 | 1K | 2K | 4K | 8K |
|----------|----|-----|-----|-----|----|----|-----|-----|
| K_{sk} | 8 | -9 | -3 | -3 | -5 | -6 | -17 | -21 |

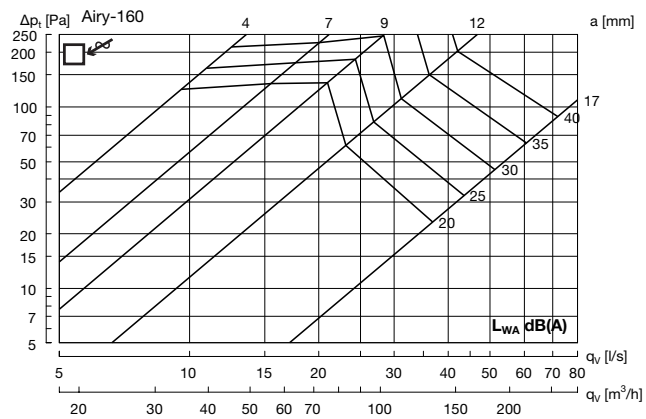

| Hz | 63 | 125 | 250 | 500 | 1K | 2K | 4K | 8K |
|----------|----|-----|-----|-----|----|-----|-----|-----|
| K_{sk} | 11 | -8 | -2 | -2 | -4 | -10 | -19 | -17 |

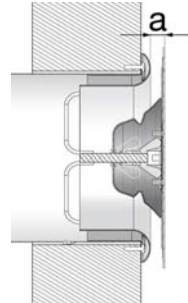

- 1
- 2
- 3
- 4
- 5
- 6
- 7
- 8
- 9
- 10
- 11
- 12
- 13
- 14
- 15
- 16
- 17
- 18

Valve – Supply and exhaust air

AIRY

Airy with bend and T-piece

Sound correction values:

Add this value to the diagram for Airy when using T-piece or bend.

Supply air

| Ød1 nom | TCPU | BKU | BU | BSU |
|------------|------|-----|----|-----|
| 100 | 3 | 1 | 1 | 0 |
| 125 | 2 | 2 | 1 | 0 |
| 160 | 5 | 5 | 4 | 3 |

Exhaust air

| Ød1 nom | TCPU | BKU | BU | BSU |
|------------|------|-----|----|-----|
| 100 | 2 | 1 | 0 | 0 |
| 125 | 2 | 2 | 1 | 0 |
| 160 | 5 | 5 | 4 | 2 |

TCPU



BKU



BU



BSU

